

POWERFLEX®

PART NUMBER

PFR19-1917

DESCRIPTION

REAR TRAILING ARM BUSH

INSTALLATION GUIDE

FITTING INSTRUCTIONS



Contents (parts per pack):

2 x Polyurethane A Bushes	4 x M8 Nylock Nut	2 x Small Steel Mounting Plate
2 x Polyurethane B Bushes	4 x Spring Pins	2 x Large Steel Mounting Plate
1 x PTFE/Silicone Grease	4 x M8 Bolts	

*Please read the complete fitting instructions and check package contents before fitment.
These fitting instructions are to be used as a guide only and in conjunction with a workshop manual.*

It is recommended that:

- All work is carried out by a licensed technician.
- All safety precautions are followed and adhered to.
- Wheel alignment to be checked and adjusted as required after any suspension work.
- All fasteners must be tensioned to the manufacturer's torque settings.

Fitting Instructions:

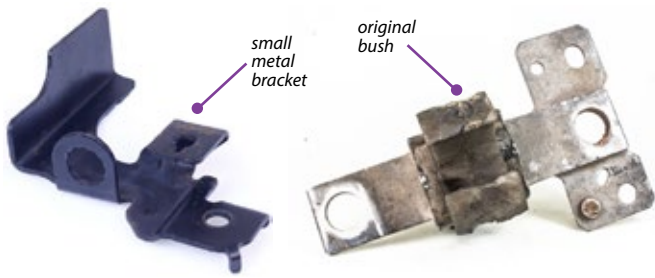

1. Remove the original bush from the trailing arm, including its outer shell using a puller or by cutting it out and retain the small metal brake hose bracket.



2. Clean any dirt or corrosion from the bore of the arm and file off any sharp edges with a rounded file.
3. Apply some washing-up liquid to the bore of the arm.

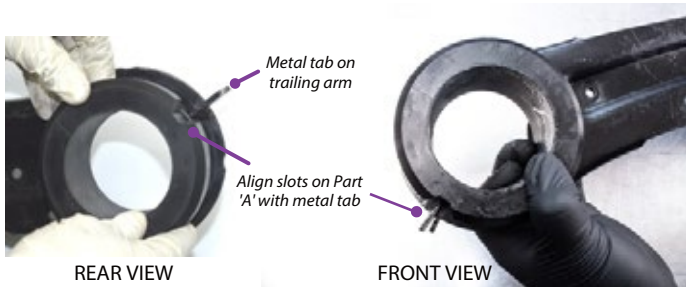

4. Present Bush A to the trailing arm, and align the slot on the bush with the welded tab on the arm.

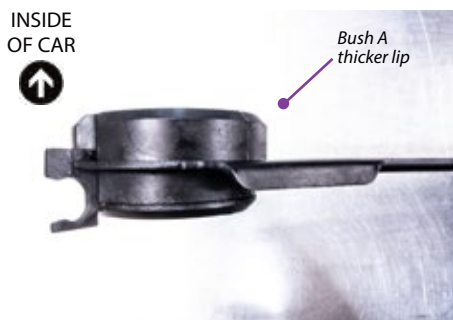

5. Using suitable adaptors or a specific fitting tool, press Bush A into the arm with the smaller lip facing towards the outside of the vehicle.

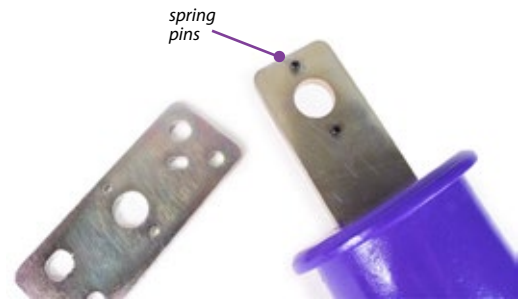

6. Push the spring pins into the long bracket bonded within Bush B until flush on one side.



7. Apply the supplied PTFE/Silicone grease to the bore of Bush A.



8. Push Bush B into Bush A from the inside direction of the car, with the larger lips of each bush being on the same side of the trailing arm.

NB: Ensure that suitable adaptors or pressing tools are used and that any force is applied to the bush face and not on the bonded metal bracket.

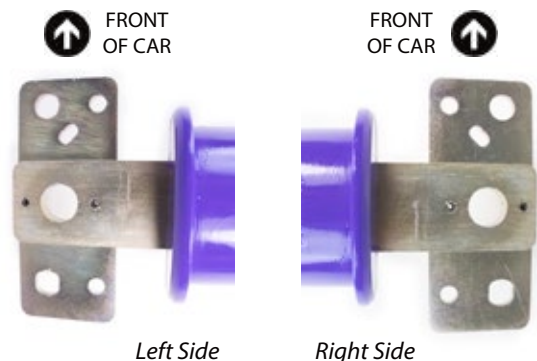

9. With the spring pins inserted, attach the smaller of the plates to the bracket to create a T-shape.

Fitting Instructions:

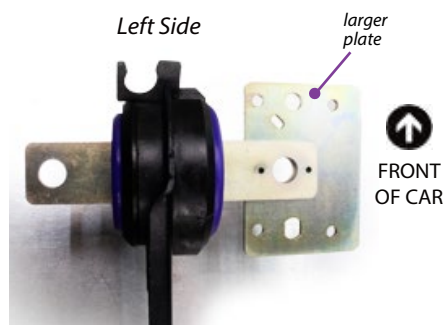

10. The left-hand bush on certain Volvo S60, S80, V60, V70, XC60, and XC70 models features a larger plate with two additional threaded studs for an exhaust hanging bracket. If this is present on your vehicle, the larger steel mounting plate must be fitted to the outside of Bush B, leaving the smaller plate on the right-hand side of the vehicle.

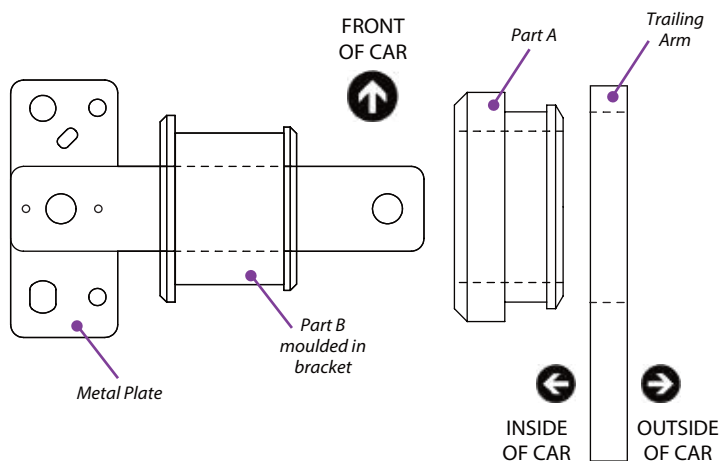

Figure 1 - How Part A and Part B fit inside the arm

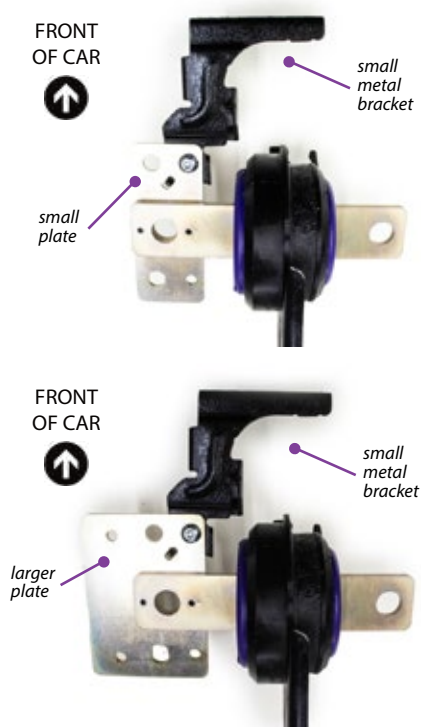

Figure 2 - Fitted into Trailing Arm

- Using the supplied M8 bolt and nut, refit the original metal brake hose bracket to the new bush.
- Refit the trailing arm to the vehicle and tension all hardware to the manufacturer's recommended torque settings.